



E-LINESMART

Equipped Desk Socket Blocks—Safe, Reliable, Efficient Solutions



E-LINESMART

Please visit our website for the updated version of our catalogues.
www.eaelectric.com



CONTENTS

►► E-LINE SMART

Innovative and Practical Solutions.....	2-3
High Performance and Aesthetic Solutions.....	4-5
Technology and Art Compliant Solutions.....	6-7
E-Line Smart STD-I Standard Free Type.....	8-9
E-Line Smart LUX-I Luxury Free Type.....	10-11
E-Line Smart LUX-II Luxury Mounted Type.....	12-13
E-Line Smart IN-I Embedded Rectangular Type.....	14-15
E-Line Smart IN-II Embedded Cylindrical Type.....	16-17
E-Line Smart SM-K / SM-MK Cylindrical Column Type.....	18-19
Technical Specifications and Order Codes	
Standard Empty Product Table.....	20
Equipment Table For Standard Products.....	21
E-Line Smart SM-LUX I Free Type / Smart SM-LUX II Mounted Type.....	22
E-Line Smart SM-STD I / Standard Free Type.....	23
E-Line Smart SM-IN I / Embedded Rectangular Type.....	24
E-Line Smart SM-IN II / Embedded Cylindrical Type.....	25
E-Line Smart SM-MK / Cylindrical Column Type.....	26
Cable Organizer.....	27
Dual USB Charging Device.....	28
Socket Modules.....	29-30
General Structure and Product Specifications.....	31
Declaration.....	32
Design Form.....	33

ELINESMART

►► INNOVATIVE AND PRACTICAL SOLUTIONS





Comfort, Aesthetic and Performance with E-Line Smart Series.



► **ELEGANT AND PRACTICAL SOLUTIONS FOR BUSINESS CENTERS, OFFICES AND WORKING SPACES**

- Off-the-shelf products ready for use and equipped with power (mains/ ups), data, telephone and multimedia sockets for desk jobs, meetings and presentations.
- Ergonomic and flexible design that can be fitted with modular type energy, weak current and multimedia sockets based on your personal needs and choices.

► **ANODIZED COATED ALUMINIUM BODY**

- Colour options include anodized coating, white and black.
- Rich visual and functional options based on your personal needs and choices.



Needs and Expectations
In Your Business Life.





► **FUNCTIONAL AND FLEXIBLE DESIGN**

- Structure and flexibility that can be managed in line with needs and demands.
- A wide range of cable entries and termination ends.
- Cable entries with blasting; bushed or screwless interlocking socket type.
- Structure ready for use thanks to interior connection structure and cabled and screwless connector/electric terminal.

► **INDISPENSABLE COMMUNICATION NEEDS**

- Structural and accessorial options in harmony with the work environment.
- Aesthetic and high performance body structure.





FULL SAFETY BY INNOVATIVE AND AESTHETIC DESIGN AT ANY POINT OF LIFE.



► **INNOVATIVE, AESTHETIC AND ARTISTIC**

- May be embedded into the desk or working surfaces.
- A product variety backed by fixing holder without any worry for aesthetic look.

► **TECNOLOGICAL & SAFELY**

- Product selections with optional exclusively designed box equipped with miniature circuit breaker (MCB), residual current device (RCD) or Residual Current Circuit Breaker with Over Current Protection (RCBO).
- Raw material used in all plastic parts in our products is polycarbonate (PC) and is halogen free and is within V0 flame retardant class according to UL 94 standard.
- When used for computers, TV or electronic devices, complete protection with an optional overcurrent protection device in order to protect the devices from current fluctuations.



A RICH VARIETY IN OFFICE ENVIRONMENTS
AN INTEGRATED HARMONY

ELINESMART SM-STD I

STANDARD FREE TYPE



- The structure with its highlighted aesthetics and visual aspects for table top utilization, it is an office automation socket block that can be equipped with 45-degree angled sockets with modular type.
- Upon request, it may be equipped with 2-module miniature circuit breaker with switch or Residual Current Circuit Breaker with Over Current Protection.
- It is manufactured as 6, 8 and 10 module body and utilized with 6 different socket option.
- Our standard type products are manufactured with "MULTI HOLE TYPE" cover, cable holding clamp and spring terminal. For "INTERLOCKING TYPE TERMINAL" and "CABLE GLAND" types please contact us.
- For standard products, you may select the ones that suit your needs on page 26.
- For your requests for products equipped with socket options other than standard products, you can determine such strong current, weak current and multimedia sockets at your option from the "Socket Modules" page.

CABLE ENTRY COVERS :



(1)
Multi Hole Type
Ø7 Hole (6 Quantity)
Ø12 Hole (2 Quantity)



(2)
Screwless Type With
Snap-On Connector
Ø7 Hole (4 Quantity)



(3)
Double Cable Gland Type
M16x1,5 Hole
(2 Quantity)



(4)
Single Cable Gland
Type 1
M16 x 1,5 Bush



(5)
Single Cable Gland
Type 2
M20 x 1,5 Bush



(6)
Single Cable Gland
Type 3
M25 x 1,5 Bush

■ Please specify the cover type. Standard type products are manufactured with "Multi Hole Type" covers.

■ Please call us for other cover types.



■ E-Line Smart STD I equipped with MCB and/ or RCBO

Color Options :



□ White Electrostatic
Powder Paint



■ Grey Anodized
Coating



■ Black Anodized
Coating



HIGH PERFORMANCE AT ANY STAGE OF LIFE...
HIGH QUALITY AND AESTHETIC...

ELINESMART SM-LUX I

►► LUXURY FREE TYPE



- The structure with its highlighted aesthetics and visual aspects for table top utilization, it is an office automation socket block that can be equipped with 45-degree angled sockets with modular type.
- Multi hole type side covers for cable entries.
- Our standard type products are manufactured with cable holding clamp and spring terminal.
- For standard products, you may select the ones that suit your needs on page 22.
- For your requests for products equipped with socket options other than standard products, you can determine such power, weak current and multimedia sockets at your option from the "Socket Modules" page.



Color Options :



White Electrostatic Powder Paint



Grey Anodized Coating



Black Anodized Coating

NEW TRENDS AND APPROACHES IN
POWER AND COMMUNICATION NEEDS.



ELINESMART SM-LUX II

►► LUXURY MOUNT TYPE



- The structure with its highlighted aesthetics and visual aspects for table top utilization, It can be easily fixed to the table edge with its special foot design, it is an office automation socket block that can be equipped with 45-degree angled sockets with modular type.
- Multi hole type side covers for cable entries.
- Our standard type products are manufactured with cable holding clamp and spring connector.
- For standard products, you may select the ones that suit your needs on page 22.
- For your requests for products equipped with socket options other than standard products, you can determine such power, weak current and multimedia sockets at your option from the "Socket Modules" page.



Color Options :



□ White Electrostatic Powder Paint



■ Grey Anodized Coating



■ Black Anodized Coating



IF YOUR PRIORITY IS BUSINESS LIFE,
E-LINE SMART WILL CONNECT YOU TO LIFE...

ELINESMART SM-IN I

►► BUILT-IN RECTANGULAR TYPE



- For flush type with rectangular cross section, an office automation block that can be equipped modular and 45-degree angled sockets required for work environments.
- The cover automatically flaps open with a single press only; it may be used thanks to its special lock mechanism and brush cover structure.
- Our standard type products are manufactured with cable holding clamp and spring terminal.
- Its mounting is quite easy thanks to specially developed side locking that are automatically positioned.
- For standard products, you may select the ones that suit your needs on page 24.
- For your requests for products equipped with socket options other than standard products, you can determine such power, weak current and multimedia sockets at your option from the "Socket Modules" page.



Color Options :



□ White Electrostatic Powder Paint



■ Grey Anodized Coating



■ Black Anodized Coating

SPECIAL DESIGNS IN WORK ENVIRONMENTS WITH A FUTURISTIC LOOK...
ELEGANCE AND EXCELLENCE...



ELINESMART SM-IN II

►► FLUSH CYLINDRICAL TYPE

- It is an office automation block that is utilized with 6 different model selections, equipped with modular sockets required for cylindrical working environments with flush mounted circular cross sections.
- The cover is opened automatically with a single press. Thanks to its special lock and tab mechanism and moving head piece, you can use while it is closed.
- PC mounting mechanism allows the easy installation of the cylindrical structure grey anodic coated aluminium body inside the desk.
- Our standard type products are manufactured with cable holding clamp and spring terminal.
- It is manufactured as 6 and 8 module body and utilized with 6 different socket option.

Desk Hole Diameter

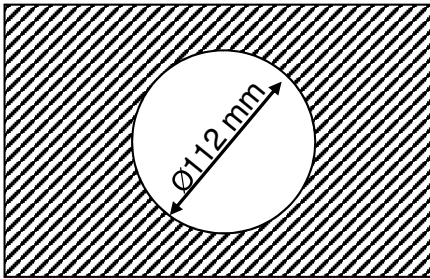

INNOVATIVE DESIGNS THAT CAN ADAPT TO DIFFERENT CONDITIONS...



ELINESMART SM-K / SM-MK

►►CYLINDRICAL COLUMN TYPE



- If high and weak current wiring cannot be moved from the flooring or the walls, this “column type” office block with its cylindrical form that can carry any energy, phone, data and multimedia sockets, which can be used to lower the cables coming from the suspended ceiling to the table level.
- It can be affixed with special connection parts between the ceiling and the flooring, for short lengths that cannot reach the ceiling, it can be affixed only on the flooring and can be utilized with 45 degree sockets with required modular types.
- The maximum length may be up to 600 cm and special orders may be produced based on the height of the ceiling.
- For shorter versions that are mounted affixed to the floor (max. 120 cm) special orders may be produced based on utilization (table height).
- For products that will be used between the ceiling and the flooring, the in-product high current cables are terminated at the upper section clamps. Phone, data and multimedia cables are laid through the specified cable input holes and may be extended to the sockets.
- In standard production, it is offered with 6 different sockets equipped.

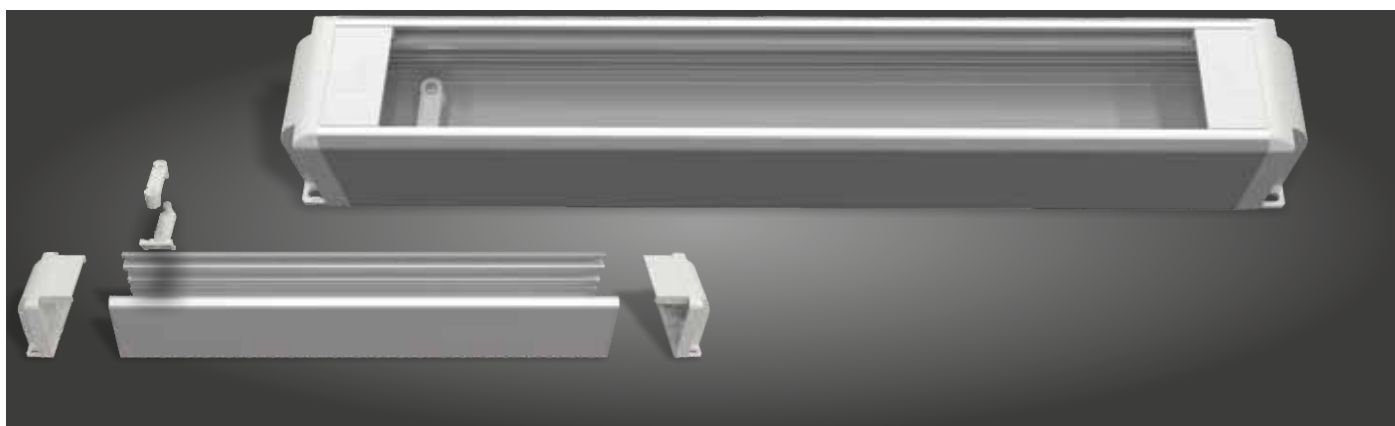

DESCRIPTIONS

1. It is manufactured without any sockets from 6 to 20 module in 8 different dimensions as standard, you can also mount the required amount and type of sockets and complete the cabling process.
2. Manufactured and sold as empty body. Our company does not complete socket mounting and cabling, and electric tests and therefore will not be held liable in an event of a failure.
3. Halogen-Free" PC/ABS side covers with multi holes for cabling and in align with the body type, the screwed cable holding clamps inside the product body and grounding terminal mounted on the body are provided with the product as standard
4. In addition to the standard lengths specified in the list, customised products may be manufactured based on request. Please contact us for details.
5. Featuring a modular type 45x45 mm or 22.5x45 mm grid and UPS power sockets and suitable for phone, data, USB, HDMI and VGA multimedia socket mounting, the socket height and aluminum profile fitting details may be different based on the brands and may experience incompatibilities, please contact us prior to order.
6. 2 (two) year warranty against production faults.

E-Line Smart SM-STD B / Standard Empty Type

Product Definition and Picture	Item No	Capacity (Module Socket)	Color	Order Code
	1	6	Grey	3178192
	2	8		3178193
	3	10		3178194
	4	12		3178195
	5	14		3178196
	6	16		3178197
	7	18		3178198
	8	20		3178199
	1	6	White	3179211
	2	8		3179212
	3	10		3179213
	4	12		3179214
	5	14		3179215
	6	16		3179216
	7	18		3179217
	8	20		3179218
	1	6	Black	3179219
	2	8		3179220
	3	10		3179221
	4	12		3179222
	5	14		3179223
	6	16		3179224
	7	18		3179225
	8	20		3179226



DESCRIPTIONS

1. Energy sockets are NE-AD. Please contact us for different brands.
2. In standard products data (CAT-6, UTP, RJ45) and telephone (Cat-3, RJ11) sockets are not included and these are only provided as "Face Plate".
3. Upon request, active and passive network products are ICS brand.. Please contact us for different brands.
4. The prices include mounting, internal cabling (for energy sockets) and multi hole type plastic side covers, the cables are "halogen-free". For customized cross sections and types, contact us.
5. Products are packaged nylon bags and cardboard boxes.
6. Products are under our 2 (two) year warranty against installation defects.
7. Our manufacture line also includes special products with any content and size based on your choices in addition to listed standard products.
8. In a capacity (module) definition, the first number refers to sockets while the second number refers to aluminium casing.

ADJUSTABLE DESK MOUNTING MATERIAL



Product description	Order Code
SM-LUX II DESK MOUNTING KIT (GREY)	2086359
SM-LUX II DESK MOUNTING KIT (WHITE)	2086360
SM-LUX II DESK MOUNTING KIT (BLACK)	2086361

Note: It should be ordered separately if needed. Suitable for SM-LUX II model.



SM-LUX II

DESK FIXING MATERIAL



Order Code : 3048968

Note: It should be ordered separately if needed. Suitable for SM-LUX I model.



SM-LUX I

ANGLED DESK MOUNTING MATERIAL



Order Code : 2080760

Note: It should be ordered separately if needed. Suitable for SM-STD I model.

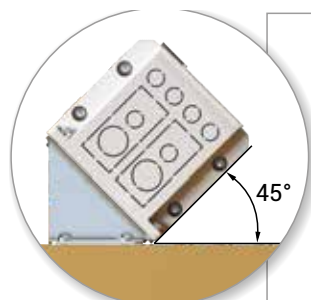

SM-STD I

Product Definition and Picture		Item No	Capacity (Module) socket/ case	Power Sockets			Active Network Products					Passive Network Products				Color	Order Code	Order Code
SM-LUX I Free Type	SM-LUX II Mount Type			Mains	UPS	USB Charge	CAT6 UTP RJ45	CAT3 UTP RJ11	USB Adap. 22,5x45	VGA Adap. 22,5x45	Face Plate 22,5x45	Face Plate 45x45	Blind Cover 22,5x45	Blind Cover 45x45	SM-LUX I Free Type		SM-LUX II Mount Type	
		1	8/14	1	2	-	-	-	-	-	2	-	-	-	Grey	3178200	3179251	
		2	10/16	2	2	-	-	-	-	-	2	-	-	-		3178201	3179620	
		3	12/18	2	2	-	-	-	-	-	4	-	-	-		3178202	3179621	
		4	14/20	3	3	-	-	-	-	-	2	-	-	-		3178203	3179622	
		5	16/22	2	4	-	-	-	-	-	4	-	-	-		3178204	3179623	
		6	18/24	3	4	-	-	-	-	-	4	-	-	-		3178205	3179624	
		1	8/14	1	2	-	-	-	-	-	2	-	-	-	White	3179227	3179625	
		2	10/16	2	2	-	-	-	-	-	2	-	-	-		3179228	3179626	
		3	12/18	2	2	-	-	-	-	-	4	-	-	-		3179229	3179627	
		4	14/20	3	3	-	-	-	-	-	2	-	-	-		3179230	3179628	
		5	16/22	2	4	-	-	-	-	-	4	-	-	-		3179231	3179629	
		6	18/24	3	4	-	-	-	-	-	4	-	-	-		3179232	3179630	
		1	8/14	1	2	-	-	-	-	-	2	-	-	-	Black	3179233	3179631	
		2	10/16	2	2	-	-	-	-	-	2	-	-	-		3179234	3179632	
		3	12/18	2	2	-	-	-	-	-	4	-	-	-		3179235	3179633	
		4	14/20	3	3	-	-	-	-	-	2	-	-	-		3179236	3179634	
		5	16/22	2	4	-	-	-	-	-	4	-	-	-		3179237	3179635	
		6	18/24	3	4	-	-	-	-	-	4	-	-	-		3179238	3179636	

E-Line Smart SM-LUX I Technical Structure And Dimensions



SM STD I Standard Free Type Product Dimensions						
Product Order Code			Module	Product Dimensions (mm)		
A.Coating	White	Black		A	B	C
3178200	3179227	3179233	8/14	355	67,5	107
3178201	3179228	3179234	10/16	400	67,5	107
3178202	3179229	3179235	12/18	445	67,5	107
3178203	3179230	3179236	14/20	490	67,5	107
3178204	3179231	3179237	16/22	535	67,5	107
3178205	3179232	3179237	18/24	580	67,5	107

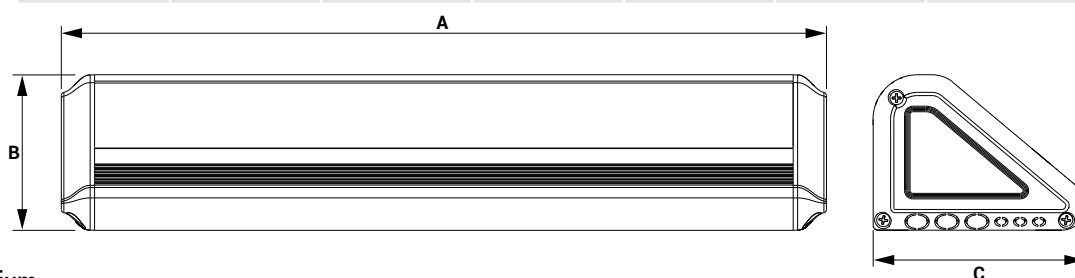

Body : Aluminium

Side Covers : PC/ABS (Polycarbonate), V2 (Flame Retardant Class), HF (Halogen Free)

■ Note: Same as SM-LUX II Mounted Type product dimensions.

Product Definition and Picture	Mains	Capacity (Module) socket/case	Power Sockets			Active Network Products					Passive Network Products				Color	Order Code
			Mains	UPS	USB Charge	CAT6 UTP RJ45	CAT3 UTP RJ11	USB Adap. 22,5x45	VGA Adap. 22,5x45	HDMI Adap. 22,5x5	Face Plate 22,5x45	Face Plate 45x45	Blind Cover 22,5x45	Blind Cover 45x45		
	1	8/14	1	2	-	-	-	-	-	-	2	-	-	-	Grey	3178185
	2	10/16	2	2	-	-	-	-	-	-	2	-	-	-		3177541
	3	12/18	2	2	-	-	-	-	-	-	4	-	-	-		3178188
	4	14/20	3	3	-	-	-	-	-	-	2	-	-	-		3178189
	5	16/22	2	4	-	-	-	-	-	-	4	-	-	-		3178190
	6	18/24	3	4	-	-	-	-	-	-	4	-	-	-		3178191
	1	8/14	1	2	-	-	-	-	-	-	2	-	-	-	White	3179239
	2	10/16	2	2	-	-	-	-	-	-	2	-	-	-		3179240
	3	12/18	2	2	-	-	-	-	-	-	4	-	-	-		3179241
	4	14/20	3	3	-	-	-	-	-	-	2	-	-	-		3179242
	5	16/22	2	4	-	-	-	-	-	-	4	-	-	-		3179243
	6	18/24	3	4	-	-	-	-	-	-	4	-	-	-		3179244
	1	8/14	1	2	-	-	-	-	-	-	2	-	-	-	Black	3179245
	2	10/16	2	2	-	-	-	-	-	-	2	-	-	-		3179246
	3	12/18	2	2	-	-	-	-	-	-	4	-	-	-		3179247
	4	14/20	3	3	-	-	-	-	-	-	2	-	-	-		3179248
	5	16/22	2	4	-	-	-	-	-	-	4	-	-	-		3179249
	6	18/24	3	4	-	-	-	-	-	-	4	-	-	-		3179250

■ Note: If necessary, it can be used with "ANGLED DESK MOUNTING MATERIAL". Please see page 21.

E-Line Smart SM-STD I / Standard Free Type Technical Specifications



SM STD I Standard Free Type Product Dimensions						
Product Order Code			Module	Product Dimensions (mm)		
A.Coating	White	Black		A	B	C
3178185	3179239	3179245	8/14	355	60	55
3177541	3179240	3179246	10/16	400	60	55
3178188	3179241	3179247	12/18	445	60	55
3178189	3179242	3179248	14/20	490	60	55
3178190	3179243	3179249	16/22	535	60	55
3178191	3179244	3179250	18/24	580	60	55

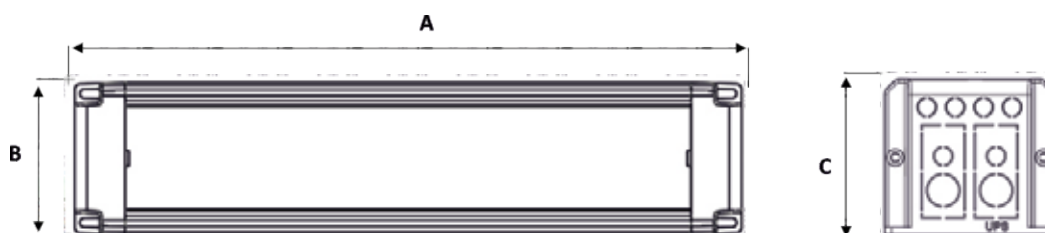

Body : Aluminium

Side Covers : PC (Polycarbonate), V0 (Flame Retardant Class), HF (Halogen Free)

Product Definition and Picture	Mains	Capacity (Module) socket/case	Power Sockets		Active Network Products					Passive Network Products				Color	Order Code	
			Mains	UPS	USB Charge	CAT6 UTP RJ45	CAT3 UTP RJ11	USB Adap. 22,5x45	VGA Adap. 22,5x45	HDMI Adap. 22,5x5	Face Plate 22,5x45	Face Plate 45x45	Blind Cover 22,5x45			Blind Cover 45x45
	1	8/14	1	2	-	-	-	-	-	-	2	-	-	-	Grey	3177542
	2	10/16	2	2	-	-	-	-	-	-	2	-	-	-		3178181
	3	12/18	2	2	-	-	-	-	-	-	4	-	-	-		3179252
	4	14/20	3	3	-	-	-	-	-	-	2	-	-	-		3179253

	1	8/14	1	2	-	-	-	-	-	-	2	-	-	-	White	3179256
	2	10/16	2	2	-	-	-	-	-	-	2	-	-	-		3179257
	3	12/18	2	2	-	-	-	-	-	-	4	-	-	-		3179258
	4	14/20	3	3	-	-	-	-	-	-	2	-	-	-		3179259

	1	8/14	1	2	-	-	-	-	-	-	2	-	-	-	Black	3179262
	2	10/16	2	2	-	-	-	-	-	-	2	-	-	-		3178183
	3	12/18	2	2	-	-	-	-	-	-	4	-	-	-		3179263
	4	14/20	3	3	-	-	-	-	-	-	2	-	-	-		3179264

E-Line Smart SM-IN I / Embedded Rectangular Type Technical Specifications



SM IN I Embedded Rectangular Type Technical Specifications										
Product Order Code			Module	Product Dimensions (mm)					Cross-Section Dim.	
A.Coating	White	Black		A	B	C	D	E	F	G
3177542	3179256	3179262	8/14	355	120	102	335	97	337	102
3178181	3179257	3178183	10/16	400	120	102	380	97	382	102
3179252	3179258	3179263	12/18	445	120	102	425	97	427	102
3179253	3179259	3179264	14/20	490	120	102	470	97	472	102

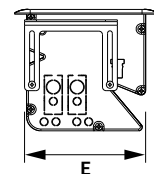
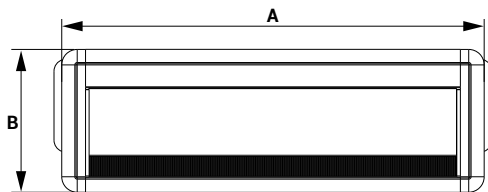

Body : Aluminium
Side Covers : PC/ABS, V2 (Flame Retardant Class) HF (Halogen Free)



EQUIPMENT TABLE FOR STANDARD PRODUCTS			
No	Order Code	Model	Equipment
1	3179195	SM-IN II 6 Module	1 MAINS+1 UPS+2 DATA PHONE FACE PLATE
2	3177543	SM-IN II 8 Module (Type-1)	1 MAINS+2 UPS+2 DATA PHONE FACE PLATE
3	3178184	SM-IN II 8 Module (Type-2)	2 MAINS+1 UPS+2 DATA PHONE FACE PLATE
4	3179197	SM-IN II 8 Module (Type-3)	1 MAINS+1 UPS+2 DATA PHONE FACE PLATE 1 USB CHARGE + 1 VGA ADAPTER
5	3179198	SM-IN II 8 Module (Type-4)	1 MAINS+1 UPS+2 DATA PHONE FACE PLATE 1 USB CHARGE + 1 HDMI ADAPTER
6	3179200	SM-IN II 8 Module (Type-5)	1 MAINS+1 UPS+2 DATA PHONE FACE PLATE 1 USB CHARGE +1 USB ADAPTER

*EQUIPMENT DESCRIPTIONS IN STANDARD PRODUCTS SECTION (PAGE 21) ARE ALSO APPLICABLE HERE.

IMPORTANT NOTE:

The electricity wiring shall be thin and multiple wire (flexible), multi-core, LSoH type (052XZ1-F 300/500V) and cable at a sufficient length shall be left to compensate the upward-downward movement of the profile body holding the sockets.



■ Grey Anodic Coated Body (Plastic part in black)

► E-Line Smart SM-IN II / Embedded Cylindrical Type Technical Structure

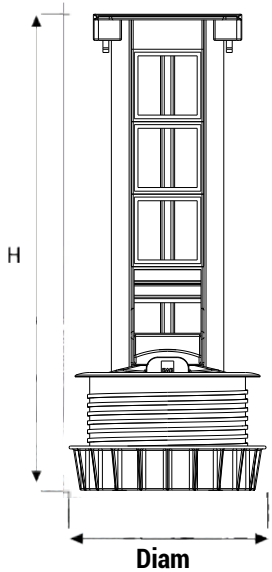

SM IN II Embedded Cylindrical Type Product Dimensions				
Product Order Code		Product Dimensions (mm)		Cross-Section Dim.
A.Coating	Module	H	B(DIAM)	D (mm)
3179195	6	280	126	112
3177543	8	330	126	112
3178184	8	330	126	112
3179197	8	330	126	112
3179198	8	330	126	112
3179200	8	330	126	112

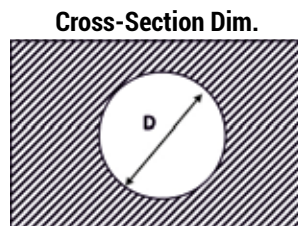
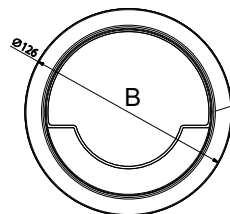

Body : Aluminium
Side Covers : PC/ABS, V2 (Flame Retardant Class), HF (Halojen Free)
Cover : PC/ABS, V2 (Flame Retardant Class), HF (Halojen Free) + 304 Stainless

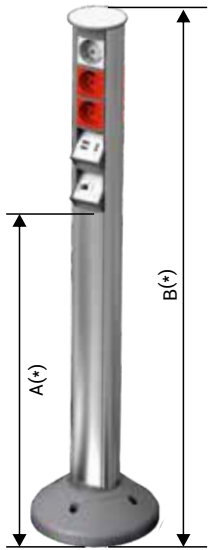

SM-MK

MINI COLUMN TYPE STANDARD PRODUCT HARDWARE TABLE					
No	Order Code	Model	Equipment	A (mm)	B (mm)
1	3179201	SM-MK 6 Module	1 MAINS+1 UPS+2 DATA PHONE FACE PLATE	750	1010
2	3179202	SM-MK 8 Module	1 MAINS+2 UPS+2 DATA PHONE FACE PLATE	750	1060
3	3179203	SM-MK 10 Module (Type-1)	2 MAINS+2 UPS+2 DATA PHONE FACE PLATE	750	1110
4	3179204	SM-MK 10 Module (Type-2)	1 MAINS+2 UPS+2 DATA PHONE FACE PLATE 1 USB CHARGE+ 1 VGA ADAPTER	750	1110
5	3177545	SM-MK 10 Module (Type-3)	1 MAINS+2 UPS+2 DATA PHONE FACE PLATE 1 USB CHARGE+ 1 HDMI ADAPTER	750	1110
6	3179205	SM-MK 10 Module (Type-4)	1 MAINS+2 UPS+2 DATA PHONE FACE PLATE 1 USB CHARGE+1 USB ADAPTER	750	1110

(*)Dimensions may be customised if required. (hmax = 120cm)

► E-Line Smart SM-K / COLUMN TYPE

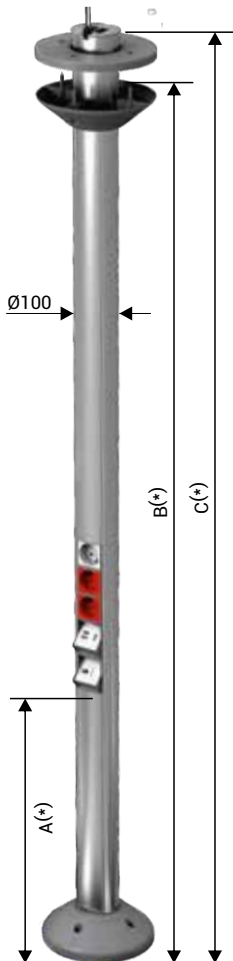

SM-K

COLUMN TYPE STANDARD PRODUCT HARDWARE TABLE						
No	Order Code	Model	Equipment	A (mm)	B (mm)	C (mm)
1	3179206	SM-K 6 Module	1 MAINS+1 UPS+2 DATA PHONE FACE PLATE	750	2800	2900
2	3179207	SM-K 8 Module	1 MAINS+2 UPS+2 DATA TEL FACE PLATE	750	2800	2900
3	3179208	SM-K 10 Module (Type-1)	2 MAINS+2 UPS+2 DATA TEL FACE PLATE	750	2800	2900
4	3179209	SM-K 10 Module (Type-2)	1 MAINS+2 UPS+2 DATA TEL FACE PLATE 1 USB CHARGE+ 1 VGA ADAPTER	750	2800	2900
5	3177544	SM-K 10 Module (Type-3)	1 MAINS+2 UPS+2 DATA TEL FACE PLATE 1 USB CHARGE+ 1 HDMI ADAPTER	750	2800	2900
6	3179210	SM-K 10 Module (Type-4)	1 MAINS+2 UPS+2 DATA TEL FACE PLATE 1 USB CHARGE+1 USB ADAPTER	750	2800	2900

(*)Dimensions may be customised if required (hmax=120 cm). (hmax = 600cm)

► E-Line Smart SM-MK (Mini Column) and SM-K (Column) Type floor and suspended ceiling plate

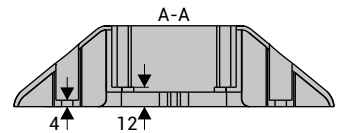
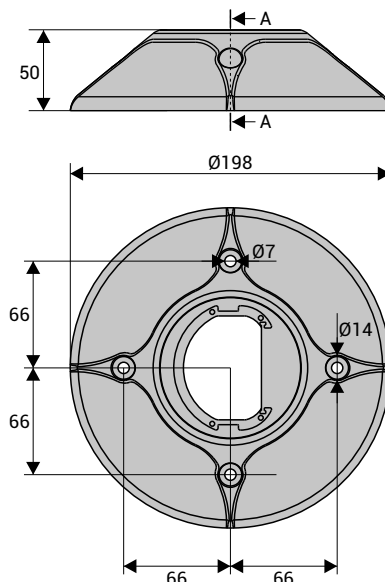

SM-K / MK Base Plate
(PC/ABS, V2 (Flame Retardant Class),
HF (Halojen Free))



To connect strong current, weak current and multi-media cables from the flooring to the desks or work environments:

- Flexible and aesthetic solution
- Produced with Halogen-Free plastic material
- Standard size = 75 cm

Order Code:

□ White
5000362



■ Grey
5000363



■ Black
5000361



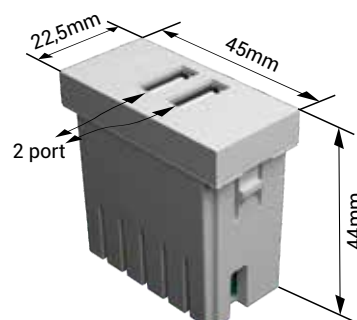

Samsung Galaxy S8 Plus Charge Duration
(0%-100%) 1 hour 45 minutes
Iphone 7 Plus Charge Duration
(0%-100%) 1 hour 45 minutes

Maximum constant operation voltage.....:220-230 V, 50/60 Hz.
Output current.....:Two port total 2,1 A
Input current.....:5V DC
Maximum operating temperature.....:125 °C (at 25 ° environment temperature) (Documented with test reports.)
Dimensions.....:45x22x43,5 mm
Weight.....:32gr
Color.....:White/Black
Body.....:Polycarbonate (PC), Glow-wire 600 °C

►► SPD SURGE PROTECTION DEVICE



Compact Multi-Pole SPD

MPE Mini & MPE Mini LED Class III • Type 3

Usage :Cable ducts and cable outputs
Network Systems :TN-S
Protection Mode :L-PE, L-N, N-PE
Fluctuation Rate :U_{cc}/I_{cw}= 6kV/3kA
I_{max}= 3kV (8/20μs)
IEC/EN Category :Class III / Type 3
Protection Elements :MOV and GDT
Safety :Warning; LED
Body :Compact design
Compatibility :IEC 61643-11:2011
EN 61643-11:2012





Maximum constant operation voltage.....:275 V - 50/60 Hz
Voltage protection rates (L, N-PE).....:1,7 kV
Voltage protection rates (L, N).....:1,5 kV
Short circuit current protection rate.....:1kA
Supporting fuse.....:MCB/B 16A
8/20μs short circuit current rate.....:3kA
1.2/50μs open circuit current rate.....:6kV
Operating temperature range.....:-40°C / +85°C
Humidity range in operating environment.....:5% - 95%
Protection level.....:IP20
Protection technology.....:"Metal Oxide Varistor" and "Gas Tube" are technological builds. Includes green LED indicator for protection term is valid. When the protection term is expired, green LED will extinguish.
Body.....:With Akulon Ultraflow K-FKG S6 (PA 6) plastic protection with UL-94 V0 Fire Retardant Rate under aluminium cover
Certification and standards.....:CE
IEC 61643-11:2011
EN 61643-11:2012

■ These products are not sold separately but provided with the product if required.

A - ENERGY MODULES			
Product Picture	Number of Modules	Product Definition	Order Code
	2	Modular Grounding Socket (Mains), German Standard, 45x45mm, 45° Angled, Child Protected, White, Single	1004270
	4	Modular Grounding Socket (Mains), German Standard, 45x45mm, 45° Angled, Child Protected, White, Double	1004272
	6	Modular Grounding Socket (Mains), German Standard, 45x45mm, 45° Angled, Child Protected, White, Triple	1003482
	8	Modular Grounding Socket (Mains), German Standard, 45x45mm, 45° Angled, Child Protected, White, Quadruple	1004243
	2	Modular Grounding Socket (Mains), French Standard, 45x45mm, 45° Angled, Child Protected, Red, Single	1004271
	4	Modular Grounding Socket (Mains), French Standard, 45x45mm, 45° Angled, Child Protected, Red, Double	1004273
	6	Modular Grounding Socket (Mains), French Standard, 45x45mm, 45° Angled, Child Protected, Red, Triple	1003483
	8	Modular Grounding Socket (Mains), French Standard, 45x45mm, 45° Angled, Child Protected, Red, Quadruple	1004242
	1	Modular On-Off Switch, 220V, 10A, Illuminated, 22,5x45 mm, White Body	1016315
	1	Dual USB Charge Adapter 2 Ports, Entry 100-240 VAC, 50-60 Hz, Output 5 VDC – 2100mA, 22,5x45mm, White/ Black	2080363

■For standard products and unless specified, energy sockets are NE-AD , USB Charger adapter is imported by EAE.
 ■Please call us for different codes.

B - ACTIVE NETWORK PRODUCTS

Product Picture	Number of Modules	Product Definition	Order Code
	-	UTP Cat-6, RJ45 Keystone Jack, Data, White and Black	1004334
	-	Cat-3, RJ11, 4 contacts, Keystone Jack, Telephone, White and Black	1004337
	1	HDMI Adapter, 22,5x45 mm, Female-Female, 90° angled, with screw, White and Black	1016317
	1	USB 3.0 Adapter, 22,5x45 mm, Female-Female, 90° angled, with screw, White and Black	1016318
	1	VGA Adapter, 22,5x45 mm, Female-Female, 90° angled, with screw, White and Black	1016319

C - PASSIVE NETWORK PRODUCTS

Product Picture	Number of Modules	Product Definition	Order Code
	1	Luxury Model Faceplate, Spring Cover, 22,5x45 mm, Transparent Protected Label Place, White	1004186
	1	Blind Plastic Cover, 22.5x45, White	1004246
	2	Blind Plastic Cover, 45x45, White	1002612
	1	USB Faceplate, 22,5x45 mm, White and Black	1016320
	1	HDMI Faceplate, 22,5x45 mm, White and Black	1016321
	1	VGA Faceplate, 22,5x45 mm, White and Black	1016322

■ Active and passive network products, for standard products and unless specified, energy sockets are NE-AD, USB Charger adapter is imported by EAE.

■ Please call us for different codes.

FITTED OFFICE SOCKET BLOCKS

1. The body is made of aluminium material and is painted with anodic or electrostatic powder paint system in white and black as colour alternatives.
2. Side plastic covers are manufactured of polycarbonate (PC) and meets "halogen free" and glow wire test conditions according to IEC 60965 and they are in "V0" flame retardant proof class according to UI94.
3. Free type standard products may be mounted to the desk by means of appropriate feet available on them if necessary.
4. Free type standard products may be screwed inside and/ or under the desk through screw holes on the side covers if necessary.
5. Covers of built-in products are opened/ closed mechanical (push open- push close) system and covers may be opened up to 90° in maximum in order to prevent breakage. Cable inlets and outlets of cover are of brush type and brushes are made of PA6 materials. The design allows covers to close easily regardless of whatever plug or adapter is connected to the socket; and when the cover is in closed position, the product will be at a maximum height of 2 mm to the desk surface.
6. Cylindrical type products have a body with "push-open" system and a brake system so that the product will not drop off to the ground when it is wide open. It is designed in a manner that when plugs are connected, it may go back to its nest inside the desk thanks to its elevator mechanism and spring cover structure so that only cable will remain and appear on the desk.
7. Standard products that can be mounted to the desk are positioned at a specific angle for easy use; and there is amoveable blanketing plate in harmony with the body at the back of the product which protects cable inlets and outlets.
8. Inside the product and in a separate chamber, there is a connector (electric terminal) connection apparatus and an interlocking, screw free connection for each conductor. Moreover, this connector tolerates and bears the traction and tensile loads of cables thank to a cable tightening clips fixed on it.
9. Connection of power sockets mounted to the product is via H07Z1-K with a cross section of 2.5mm or, upon request, 1.5mm cross-section. It is equipped with such connectors separately for UPS and Network circuits which can bear at least 16A load and connected by means of screwed and interlocking type.
10. Grounding contact screw and grounding connector fixed to the product's aluminium body is cabled with H07Z1-K cable with a cross section of 2.5mm to ensure body protection.
11. Socket mounting part is integrated to the body and every brand and universal and modular type is designed compatible with the installation of power sockets with a size of 45x45mm (2 module) and weak current and multimedia socket at a size of 45x22.5mm (1 module).
12. Mains and UPS sockets are 250V AC and 16A with 45° angle and spiked characteristicb "White" grounding sockets of German standard are used in mains circuit while "red" grounding sockets of French standard are used in UPS circuit. Phase-neutral-ground bridges of double, triple and quadruple socket systems are secured in themselves by means of brass bar.
13. For data cable connections, spring cover and label window "face plate" is used that is compatible with Cat-6 UTP "keystone jack" structure.
14. For telephone cable connections, spring cover and label window "face plate" is used that is compatible with Cat-3 "keystone jack" structure.
15. Socket mounting part is also compatible with the mounting/ installation of all standard and modular (45x45 mm and/ or 45x22.5mm) USB charging units, USB adapter, VGA adapter, HDMI adapter etc and they can be used together with all brands.
16. 45x22.5mm (1 module) size blind covers compatible with the body are used between different strong and weak current sockets and after the last socket but before the termination cover
17. For cable outputs on the desk, cable organized and protective plastic backbone Conduits with flexible structure and "halogen free" are used.

CE DECLARATION OF CONFORMITY

Product Group E-LINE SMART Equipped Desk Socket Blocks
Manufacturer EAE Elektrik Asansor End. İnşaat San. ve Tic. A.S.
Akcaburgaz Mahallesi, 3114. Sokak,
No:10, 34522 Esenyurt - İstanbul

We confirm that products or product group mentioned above manufactured in EAE Facilities conform to standards and regulations listed below.

Standard:

IEC 60670-1

"Boxes and enclosures for electrical accessories for household and similar fixed electrical installation – Part 1: General requirements"

CE - Directive:

2014/35/EU "The Low Voltage Directive"

Technical Document Preparation Official:

EAE Elektrik Asansor End. İnşaat San. ve Tic. A.S.
Akcaburgaz Mahallesi, 3114. Sokak, No:10 34522 Esenyurt-İstanbul

Emre GÜRLEYEN

Date

08/03/2021

Document Authorized Signatory

Elif Gamze KAYA OK
Genel Müdür Yardımcısı



Member List		
Serial No	Type	Pcs.
		Company : _____
		Project : _____
		Project No : _____
		Name : _____
		Date : _____
		Signature : _____
Prepared by _____		

Please duplicate this page for your own use.

Member List		
Serial No	Type	Pcs.
<div style="background-image: linear-gradient(to right, #e0e0e0 1px, transparent 1px), linear-gradient(to bottom, #e0e0e0 1px, transparent 1px); background-size: 20px 20px;"> </div>		
Company : Project : Project No :		
Name : Date : Signature :		
Prepared by		

Please duplicate this page for your own use.

PRODUCT TYPES



BUSBAR ENERGY DISTRIBUTION SYSTEMS



CABLE TRAYS



TROLLEY BUSBAR ENERGY DISTRIBUTION SYSTEMS



INDOOR SOLUTIONS



SUPPORT SYSTEMS

Please visit our website for the updated version of our catalogues.
www.eaeelectric.com



EAE Elektrik A.S.
Akcaburgaz Mahallesi,
3114. Sokak, No:10 34522
Esenyurt - Istanbul - TURKEY
Tel: +90 (212) 866 20 00
Fax: +90 (212) 886 24 20

EAE Elektrik Gebze Fabrika
Gebze IV Istanbul Makine ve
Sanayicileri Organize Bolgesi
6.Cadde No.2 Demirciler Koyu
Dilovasi - KOCAELI - TURKEY
Tel: +90 (262) 502 05 65
Fax: +90 (262) 502 05 70

Please visit our website for the updated version of our catalogues.
www.eaeelectric.com

IEC 61439-6 



Catalogue 31-EN. / Rev 05 1000 pcs 31/05/2021
S.S.

We reserve the right to make changes in the values given in the catalogue.